

# ANIMATED ANDROIDS

*Robotics - A Student Inquiry Project*

*LEGOS-Mindstorms*



**Gwen Foote, Science Dept Chair/Teacher**

[gfoote@dadeschools.net](mailto:gfoote@dadeschools.net)

**Nautilus Middle School –IB World School**

**4301 N Michigan Ave**

**Miami Beach, FL**

**305-532-3481**

**School Mail Code 6541**

**SPONSORED BY**



## Table of Contents

	Page
Goals & Objectives.....	3
Common Core & New Generation State Standards.....	3
Course Outline/ Overview: A Student Inquiry Program.....	5
Lesson Plans .....	6
Lesson 1: Introduction to Robotics.....	6
Lesson 2: Scientific Method .....	7
Lesson 3: Transformation of Energy .....	11
Lesson 4: The Energy of Waves (Light & Sound) .....	14
Lesson 5: MINDSTORMS Motivation.....	18
Lesson 6: <b>I Have an APP for That</b> (Electromagnetic Spectrum Pt.2).....	21
Lesson 7: The Masters of Metaphorosis (R&D).....	23
Lesson 8: Competitions	
Tech Titans- Robot Crush Challenge.....	25
MINDSTORMS- / Course Challenge & Competition.....	26
STEM- SECME (Science Engineering Communication Mathematics Enhancement).28	
Assessments .....	29
Resource List .....	30
Appendices-Reading Passages/Worksheets .....	31
A Reading Passage - Lesson#1.....	32
B Student Design Cycle & Worksheets #2 .....	37
C Student Rubrics -Lesson #2.....	40
D Forms of Energy Diagram -Lesson #3.....	41
E Reading Passage -Lesson #4.....	42
F Student Rubrics-Collaborative Work Skills .....	46



## LESSON MODULE

# ANIMATED ANDROIDS

## *Robotics - A Student Inquiry Project*

### GOALS & OBJECTIVES/ COMMON CORE STATE STANDARDS

#### OBJECTIVES:

Students will:

- ⊕ Students will identify
  - that scientific theories are explanations and laws describe relationships, and both are supported by evidence.
  - Identify a benefit of using a model to explain how things work.
- ⊕ Students will develop their sense of science process, investigation and data analysis and interpretation through
  - Personal research and
  - Use of data findings through technology.

#### COMMON CORE STATE STANDARDS:

#### CCSS: ENGLISH LANGUAGE ARTS STANDARDS 6-8:

#### LACC.68. STANDARDS FOR LITERACY IN HISTORY, SOCIAL SCIENCE, SCIENCE, AND TECHNICAL SUBJECTS

RST.3.7: Integrate quantitative or technical information expressed in words in a text with a version of that information expressed visually (e.g., in a flowchart, diagram, model, graph, or table).

WHST.3.7 Conduct short research projects to answer a question (including a self-generated question), drawing on several sources and generating additional related, focused questions that allow for multiple avenues of exploration.

LA.6.4.2.2 The student will record information (e.g., observations, notes, lists, charts, legends) related to a topic, including visual aids to organize and record information and include a list of sources used

LA.6.2.2.3 The student will organize information to show understanding (e.g., charting, mapping, paraphrasing, summarizing, or comparing/contrasting

Math Standards 6-8:  
MA.6.A.3.6 Construct and analyze tables, graphs, and equations to describe linear functions and other simple reactions using both common language and algebraic notation.

## **NEXT GENERATION SCIENCE STANDARDS (NGSS) 6-8:**

### **BIG IDEA 1: THE PRACTICE OF SCIENCE**

- SC.7.N.1.1 Define a problem from the seventh grade curriculum, use appropriate reference materials to support scientific understanding, plan and carry out scientific investigation of various types, such as systematic observations or experiments, identify variables, collect and organize data, interpret data in charts, tables, and graphics, analyze information, make predictions, and defend conclusions.
- SC.7.N.1.2 Differentiate replication (by others) from repetition (multiple trials).
- SC.7.N.1.3 Distinguish between an experiment (which must involve the identification and control of variables) and other forms of scientific investigation and explain that not all scientific knowledge is derived from experimentation.
- SC.7.N.1.4 Identify test variables (independent variables) and outcome variables (dependent variables) in an experiment
- SC.7.N.1.5 Describe the methods used in the pursuit of a scientific explanation as seen in different fields of science such as biology, geology, and physics.
- SC.7.N.1.7 Explain that scientific knowledge is the result of a great deal of debate and confirmation within the science community.

### **BIG IDEA 2 THE CHARACTERISTICS OF SCIENTIFIC KNOWLEDGE**

- SC.6.N.1.5 Recognize that science involves creativity, not just in designing experiments, but in also creating explanations that fit evidence.
- SC.6.N.2.1 Distinguish science from other activities involving thought
- SC.6.N.2.2 Explain that scientific knowledge is durable because it is open to change as new evidence or interpretations are encountered
- SC.7.N.3 Identify that scientific theories are explanations and laws describe relationships, and both are supported by evidence.  
Identify a benefit of using a model to explain how things work.

### **BIG IDEA 3 THE ROLE OF THEORIES, LAWS, HYPOTHESES, AND MODELS**

- SC.7.N.3 The terms that describe examples of scientific knowledge, for example; "theory," "law," "hypothesis," and "model" have very specific meanings and functions within science.

### **BIG IDEA 10: TRANSFORMATION OF ENERGY-FORMS OF ENERGY**

- SC.7.P.10.2 Energy exists in many forms and has the ability to do work or cause a change  
Observe and explain that light can be reflected, refracted, and/or absorbed

### **BIG IDEA 11: ENERGY TRANSFER AND TRANSFORMATIONS**

- SC.7.P.11.2 Investigate and describe the transformation of energy from one form to another
- SC.7.P.11.3 Cite evidence to explain that energy cannot be created nor destroyed, only changed from one form to another.
- SC.6.P.11 The Law of Conservation of Energy: Energy is conserved as it transfers from one object to another and from one form to another. Identify energy as stored (potential) or expressed in motion (kinetic).

## Course Outline/ Overview

### ANIMATED ANDROIDS

#### *Robotics - A Student Inquiry Project*

### ANDROID ROBOT CHALLENGE

In a society that is going digital, computerized, remote, and technology savvy, it is important to teach these standards with our students. Mindstorms from LEGO Education can provide the opportunities we want and students need. This is an amazing program that motivates more students to get involved in S.T.E.M. competitions.

Students participate in a “How To”- PowerPoint presentation in building robots and the significance of bionics. Teachers can convert their class to a hands-on learning inquiry laboratory in the research and design in robotics. Students follow pictorial instructions in modeling real life mechanisms with critical thinking – reasoning and problem solving skills -to meet challenges while learning applications in science, technology, engineering, and math concepts.

This project is aligned with the Common Core State Standards and curriculum of the practice of science, Newton’s laws of motion, energy, electromagnetic spectrum, and sounds waves with the use of sensors. Alternative energy add-on sets can be included with lessons in solar, wind, and water to generate, store, and use of power for renewable resources. The robots can be controlled and maneuvered with a free downloaded App on Android phones, tablets, or laptops using Bluetooth. Students can design and build a challenge course for competing with each other in a Challenge Course Competition.

Robotics activities and lessons with LEGOs Mindstorms, is an exciting and engaging module that is teacher and user friendly. Lessons in this packet are integrated with the required curriculum objectives and supported by online instructions and teachers’ resources. The resources make it easy to implement activities. Students enjoy working with applications of the technology in science/ STEM objectives. Instructions for construction, programming, and remote control applications are presented with software and online pictures in a step by step process. Students work in collaborative groups for planning, decision making, construction, and student performance presentations. They can adapt, change, or use any design from the online or hard copy manual.

## **Lesson Plans**

### **Lesson 1** – Reading Research (See Appendix for Lesson 1-Reading)

## **INTRODUCTION TO ROBOTICS**

### **What is a Robot?**

- I. Learning outcomes:
  - Name the characteristics that defines 3 generations of robots
  - Explain differences between systems, black box, and functional units.
  - Define power supply, central processor, sensor, & actuator sections of a robot.
- II. Directions for program learning
  - Read carefully, to be tested on knowledge later.
  - Underline or highlight words and ideas.

When did the trend of robotics start?

Students will develop their sense of science process, investigation with data analysis, and their interpretation through personal research and use of data findings through technology.

(SEE APPENDIX -Lesson 1 FOR STUDENT READING LESSON)

## **Lesson 2- Scientific Method**

**NGSS: SC.7.N.1.1** Define a problem from the seventh grade curriculum, use appropriate reference materials to support scientific understanding, plan and carry out scientific investigation of various types, such as systematic observations or experiments, identify variables, collect and organize data, interpret data in charts, tables, and graphics, analyze information, make predictions, and defend conclusions. (Assessed as SC.8.N.1.1)

**SC.7.N.1.2** Differentiate replication (by others) from repetition (multiple trials). (AA)

**SC.7.N.1.4** Identify test variables (independent variables) and outcome variables (dependent variables) in an experiment. (Assessed as SC.8.N.1.1)

**SC.7.N.1.7** Explain that scientific knowledge is the result of a great deal of debate and confirmation within the science community. (Assessed as SC.7.N.2.2)

**SC.7.N.2.1** Identify an instance from the history of science in which scientific knowledge has changed when new evidence or new interpretations are encountered. (Assessed as SC.6.N.2.2)

**Objectives:** When organizing and planning their work, students should follow all four elements of the design cycle. In the early stages a stronger emphasis is given to creating a product/solution, but as experience with the design cycle progresses, investigating, planning and evaluating will also be addressed.

It is expected that students will use the process in all learning, including technology-related projects.

### **HOW TO PREPARE A PROJECT**

1. **Select a Topic:** Choose a topic you are interested in. Research on Internet and talk to teachers and parents.
2. **Research:** After choosing a topic, research through Internet, Libraries, science journals, and magazines. Contact experts and companies.
3. **Purpose & Hypothesis:** The purpose is a description of the problem & what you will do. The hypothesis is an educated explanation of what you predict will happen.
4. **Experiment:** Plan and organize your experiment. List your materials and write out your procedure. Keep careful records of data in your science journal.
5. **Research paper:** This report will provide interested readers with comprehensive information about your topic and research. It includes data collected and a description of your experiment, data, and conclusions.  
Include your Abstract and cite your sources.
6. **Exhibit:** This is the visual display of your project. Use computerized graphs, charts, and tables, in clear legible lettering.
7. **Judging:** Plan how you will present your project visually and informatively.

## Parts of a Lab Report

### Step-by-Step Checklist

A lab report is documentation for the project, expected outcomes, research, and results. A lab report is a journal of the investigation. Below are components of a lab investigation.

#### Title

**Benchmarks Covered:** Provided by the teacher: It is a summary of the main concepts to be learned while conducting the experiment.

#### **Problem Statement:**

Identify the research question / problem. State it clearly in the form of **a question**.

#### **Potential Hypothesis (es):**

- ✓ State the hypothesis carefully. It is not just a guess.
- ✓ Write the hypothesis logically and, if appropriate, with a calculation.
- ✓ Write down your prediction with the tested, manipulated variable (independent variable) and how it will affect the outcome variable (dependent variable).

#### **Materials:**

- ✓ Record precise details of all equipment used, For example: a balance that measures with an accuracy of +/- 0.001 g, or frequency, wavelength, speed and acceleration.

#### **Procedure:**

- ✓ Do not just copy the procedures from the lab manual or handout.
- ✓ Summarize the procedures in sequential order, with critical steps.
- ✓ Give accurate and concise details about the equipment, apparatus, and materials used.

#### **Variables and Control Test:**

- ✓ Identify the variables in the experiment. State those over which you have control. There are three types of variables.
  1. **Test / manipulated variable** (independent variable): the factor that can be changed by the investigator (the cause).
  2. **Outcome variable** (dependent variable): observable factor of an investigation which is a result of what happened when *test variable (independent variable)* is changed.
  3. **Controls** (factors held constant): other identified test variables in investigations that are kept or remain the same during the investigation.
  4. Identify the **control test**. A control test is the separate experiment that serves as the standard for comparison to identify experimental effects, changes of the outcome (dependent) variable resulting from changes made to test variables.

#### **Data:**

- ✓ Record all data, with particular attention to significant figures and labeled units.
- ✓ Present your results clearly in a table or a graph, with a title, each axis is labeled clearly, and the correct scale in the graph space.
- ✓ Record qualitative observations, with the environmental conditions (color changes, solubility changes, and if heat was released or absorbed).

**Results:** Ensure that all recorded your data is correct for accurate results.

Include any errors or uncertainties that may affect the validity of your result.



**Conclusion and Evaluation:** A conclusion statement answers the following 7 questions in at least three paragraphs.

**I. First Paragraph: Introduction**

1. What was investigated?
  - a) Describe the problem or state the purpose of the experiment.
2. Was the hypothesis supported by the data?
  - a) Compare your actual result to the expected result (either from the literature, textbook, or your hypothesis)
  - b) Include a valid conclusion that relates to the initial problem or hypothesis.
3. What were the major findings?
  - a) Did the findings support or not support the hypothesis as the solution to the restated problem?
  - b) Calculate the percentage error from the expected value.

**II. Middle Paragraphs: These paragraphs answer question 4 and discuss the major findings of the experiment using data.**

4. How did the findings compare with other researchers?
  - a) Compare results to other students' results in the class.
    - i) The body paragraphs support the introductory paragraph by elaborating on the different pieces of information that were collected as data that either supported or did not support the original hypothesis.
    - ii) Each finding needs its own sentence and relates back to supporting or not supporting the hypothesis.
    - iii) The number of body paragraphs you have will depend on how many different types of data were collected. They will always refer back to the findings in the first paragraph.

**III. Last Paragraph: Conclusion**

5. What possible explanations can be offered for the findings?
  - a) Evaluate method.
  - b) State any procedural or measurement errors that were made.
6. What recommendations are there for further study and for improving the experiment?
  - a) Comment on the limitations of the method chosen.
  - b) Suggest how the method chosen could be improved to obtain more accurate and reliable results.
7. What are some possible applications of the experiment?
  - a) How can this experiment or the findings of this experiment be used in the real world for the benefit of society.

## CONCLUSION WRITING

### Claim, Evidence and Reasoning

Students should support their own written claims with appropriate justification. Science education should help prepare students for this complex inquiry practice where students seek and provide evidence and reasons for ideas or claims (Driver, Newton and Osborne 2000). Engaging students in explanation and argumentation can result in numerous benefits for students. When students develop and provide support for their claims they develop a better and stronger understanding of the content knowledge (Zohar and Nemet, 2002).

When students construct explanations, they actively use the scientific principles to explain different phenomena, developing a deeper understanding of the content. Constructing explanations may also help change students' views of science (Bell and Linn, 2000). Often students view science as a static set of facts that they need to memorize. They do not understand that scientists socially construct scientific ideas and that this science knowledge can change over time. By engaging in this inquiry practice, students can also improve their ability to justify their own written claims (McNeill et al.2006).

Remember evidence must always be:

- Appropriate
- Accurate
- Sufficient

(SEE APPENDIX -Lesson 1 FOR STUDENT WORKSHEET, DIAGRAM, & RUBRIC)

[www.science.dadeschools.net](http://www.science.dadeschools.net)

<http://science.dadeschools.net/middleSchool/essentialLabs.html>

[McNeill, K. L. & Krajcik, J. \(2008\). Inquiry and scientific explanations: Helping students use evidence and reasoning. In Luft, J., Bell, R. & Gess-Newsome, J. \(Eds.\). Science as inquiry in the secondary setting. \(p. 121-134\). Arlington, VA: National Science Teachers Association Press.](#)

## **LESSON 3 –Transformation of Energy**

The Law of Conservation of Energy & Transformation of Energy Transfers

(from one system to another)

### **NGSS Goals:**

#### **Big Idea 1: The Practice of Science**

**SC.6.N.1.1** Define a problem from the sixth grade curriculum, use appropriate reference materials to support scientific understanding, plan and carry out scientific investigation of various types, such as systemic observations or experiments, identify variables, collect and organize data, interpret data in charts, tables, and graphics, analyze information, make predictions, and defend conclusions.

**SC.7.N.1.3** Distinguish between an experiment (which must involve the identification and control of variables) and other forms of scientific investigation and explain that not all scientific knowledge is derived from experimentation. (Assessed as SC.8.N.1.1)

#### **Big Idea 2: The Characteristics of Scientific Knowledge**

**SC.6.N.2.3** Recognize that scientists who make contributions to scientific knowledge come from all kinds of backgrounds and possess varied talents, interests, and goals

#### **Big Idea 10: Energy**

**SC.6.N.1.3** Explain the difference between an experiment and other types of scientific investigation, and explain the relative benefits and limitations of each.

**SC.6.E.7.1** Differentiate among radiation, conduction, and convection, the three mechanisms by which heat is transferred through Earth's system

**SC.912.P.10.4** Describe heat as the energy transferred by convection, conduction, and radiation, and explain the connection of heat to change in temperatures or states of matter

#### **Big Idea 11: Energy Transfers and Transformations**

**SC.6.P.11.1** Explore the Law of Conservation of Energy by differentiating between potential and kinetic energy. Identify situations where potential energy is transformed into kinetic energy and vice versa.

**SC.7.P.11.2** Investigate and describe the transformation of energy from one form to another.

**SC.7.P.11.3** Cite evidence to explain that energy cannot be created nor destroyed, only changed from one form to another.

### **Common Core Standards**

**LA.6.4.2.2** The student will organize information to show understanding (e.g., representing main ideas within text through charting, mapping, paraphrasing, summarizing, or comparing/contrasting)

**MA.6.A.3.6** Construct and analyze tables, graphs, and equations to describe linear functions and other simple relations using both common language and algebraic notation.

**Objectives/ Purpose:** To introduce energy transfer and the transformation processes

- Explore the Law of Conservation of Energy by differentiating between potential and kinetic energy.
- Identify situations where kinetic energy is transformed into potential energy and back.
- Differentiate among radiation, conduction, and convection, the three mechanisms by which heat is transferred through Earth's system.

**Vocabulary:** Forms of Energy & Transformations- Law of Conservation of Energy,

**CEMENT** - Chemical energy

Electrical energy

Mechanical energy

Electromagnetic radiation

Nuclear energy

Thermal energy

potential energy, kinetic energy, radiant energy, energy conversion, exothermic reaction, friction

### **Background Information**

Energy comes in many forms. Two states of energy is kinetic and potential energy which are inversely proportional. Types of energy are Chemical energy, Electrical energy, Mechanical energy, Electromagnetic radiation, Nuclear energy, and Thermal energy. These forms of energy are related and can be transformed from one form into another.

Energy cannot be lost, created, or destroyed. It only changes form and can be absorbed or given off, in the term transformed. This means that energy lost must be balanced by a gain in equal amounts of energy by one or more objects. This transfer involves a change of form of the energy that is transferred. The most common type of energy transformation is a form of energy to heat or thermal energy.

**The Law of Conservation of Energy** states that the total amount of energy in a system remains constant, although energy can be changed from one form to another or transferred from one object to another.

Students will

Demonstrate Achievement of the following Goals:

- Develop a **problem statement** based on the Law of Conservation of Energy that includes the transformation of energy from potential to kinetic and vice versa.
- Create a model to demonstrate the concept/idea outlined in your problem statement above.
- How does the model demonstrate the concept/idea that you investigated?
- Use the “**Claim, Evidence & Reasoning**” rubric to defend your claims when writing your conclusion.

### **Procedure:**

Students will work in small collaborative learning groups to achieve the following:

- Demonstrate kinetic and potential energy
- Test for the effect of varying mass and height (distance through which gravity acts) on kinetic and potential energy.
- Recognize the total energy in a system is equal to the sum of the potential and kinetic energy.
- Design, construct, and test a robotic structure to illustrate transformation of several forms of energy as it travels

**Engage:**

1. Have students make signs for the two types of energy (Kinetic and Potential) and place the energy signs on the board.
2. Students will make signs for all the different forms of energy, i.e. mechanical, solar, nuclear, sound, thermal, heat, light, chemical, electrical, geothermal, hydroelectric and wind. Place these signs on the board with either magnets or tape.
3. Discuss with students under which category (KE or PE) each form of energy should be placed. Note each form could be placed in either category.

**Explore:**

1. Give each team a battery, wires, light bulb, and fixtures
2. Explain that they will put together a circuit to get the light bulb to work.
3. When their circuit works they will sketch their system in their journal
4. Give each team another light bulb and have them complete the same circuit with 2 light bulbs. Sketch and label this system.

**Explain:**

1. Teams will discuss the transformation of energy in each circuit.
2. Their sketch will be marked with each transformation and what type of energy happened.
3. For each sign of the type of energy, teams will present their explanation of where and how this type of energy was demonstrated
4. Students should infer what they could have done to create a circuit for a bulb that would burn brighter.

Ask the students if they think that other types of energy can change from one form to another. Refer to the list on the board, **CEMENT** (memory acronym).

Ask students if they can think of an example of light energy being converted to some other type of energy. Examples: photosynthesis (light energy to chemical energy), solar power (light energy to electrical energy). These are both important ways in which light energy changes form.

(SEE APPENDIX -Lesson 3FOR STUDENT WORKSHEET)

## LESSON 4 THE ENERGY OF WAVES: Model Eliciting Activity (MEA)

### The Energy of Light



### Model-Eliciting Activity

In this introduction to light energy, students will learn about reflection and refraction of light as it travels in wave form. Engaged in hands on activities, they will see how prisms, magnifying glasses and polarized lenses work. They also gain an understanding of color in rainbows as the visible spectrum, with each color corresponding to a different wavelength.

Connection to engineering: Engineers use properties of light to create many inventions. To reduce energy consumption, engineers take advantage of solar energy, reflected sunlight in a room. Engineers create lasers, and properties of light are used in the design of cameras, medical equipment, microscopes, and programming computers for the manipulation of machines.

#### **OBJECTIVES:**

Students will

- Understand that light is a form of energy that it can be characterized as a wave.
- Comprehend that different colors of the spectrum represent light waves vibrating at different frequencies.
- Describe reflection and refraction of light waves.
- Understand how engineers use light waves.
- Understand that a prism sorts a light beam into its various wavelengths, appearing as a rainbow of colored light.

#### **Benchmarks- NGSS:**

- **Benchmarks:**
- **SC.7.N.1.3** Distinguish between an experiment (which must involve the identification and control of variables) and other forms of scientific investigation and explain that not all scientific knowledge is derived from experimentation. (Assessed as SC.8.N.1.1)
- **SC.7.N.1.4** Identify test variables (independent variables) and outcome variables (dependent variables) in an experiment. (Assessed as SC.8.N.1.1)
- **SC.7.P.10.2** The student observes and explains that light can be reflected, refracted, and absorbed. (Assessed as SC.7.P.10.3)
- **SC.7.P.10.3** The student recognizes that light waves, sound waves and other waves move at different speeds in different materials. (AA)

## Model-Eliciting Activity

MEAs are activities using open-ended problems that encourage students to create solutions in the form of mathematical and scientific models by providing a data set and problem-solving tasks. In an MEA lesson, the teacher provides:

- 1) a reading passage that sets up the problem and provides context,
- 2) readiness questions to ensure that students understand the problem,
- 3) a data set for students to use to solve the problem, and
- 4) a problem-solving task, and
- 5) an additional data set can be provided.

(SEE APPENDIX -Lesson 4 FOR STUDENT READING PASSAGE & WORKSHEET)

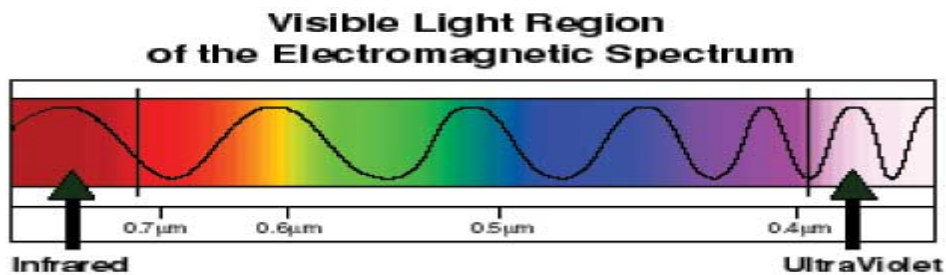
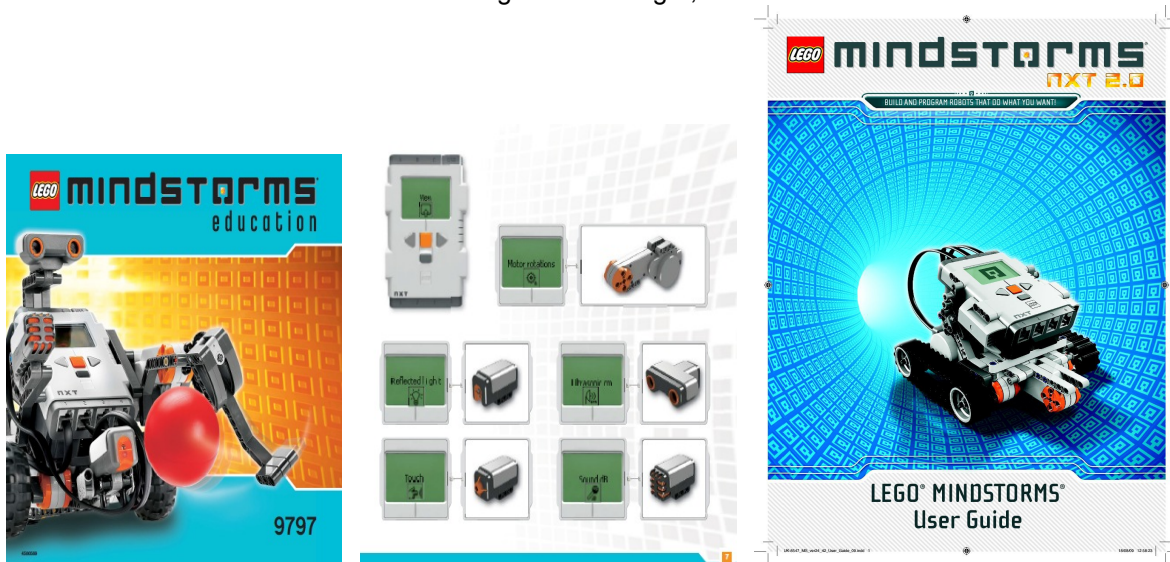

Figure 1. The colors and wavelengths of the visible light spectrum. Note the order of the colors (ROYGBIV), and their varying wavelengths. Red is the longest wavelength, violet the shortest



User Guides provide building instructions for light sensors with robotics. Teams design prototype models on graph paper for collaborative learning assignments and creating blueprints for robotics models.

# Hands on Exploration

## NXT TECHNOLOGY



### COLOR SENSOR

The Color Sensor is one of the sensors that gives your robot vision (the Ultrasonic Sensor is the other). The Color Sensor actually has three different functions in one. The Color Sensor enables your robot to distinguish between colors and light and dark. It can detect 6 different colors, read the light intensity in a room and measure the light intensity of colored surfaces. The Color Sensor can also be used as a Color Lamp.



#### Suggestions for use

You can use the Color Sensor to sort your LEGO® bricks, or to make a robot that will follow a red line or change direction when it detects a red spot. You can also use the sensor as a color lamp to give your robot extra personality.



#### Using the sensor as a color sensor

To get optimal color detection, the sensor should be held at a right-angle approximately 1 cm to the surface. Incorrect color readings can occur if the sensor is held at other angles to the surface or if it is used in bright light.



## NXT TECHNOLOGY



### Using the sensor as a Light Sensor

The sensor can be used to take single light intensity readings. It functions as a light sensor when the light color is set to red. Using another light color (green or blue) can give different results.

The sensor can be used to take readings of light intensity from ambient or reflected light. Any of the three colors can shine when reading reflected light.



### Using the sensor as a Color Lamp

You can use the sensor as a color lamp to control the individual output colors (red, green or blue) and add personality to your robot.

### Test it!

You can test the color sensor in different ways:  
Connect the color sensor to the NXT.

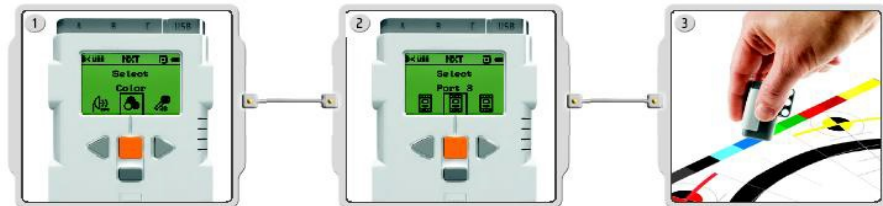

Select the View submenu on the NXT's display. Select the color sensor icon and the port where you have connected the sensor.

Hold the color sensor approximately 1 cm above the different colors on the Testpad, and the NXT's display will show the value and name of the color.

Select the Try My submenu on the NXT's display and test your Color Sensor. You'll get a fun reaction.

## **LESSON 5: MINDSTORMS Motivation**



### **NGSS Standards /Goals:**

#### **Physical Science Honors Curriculum (SC.8.N.1.1;SC.7.N.1.2;SC.6.N.2.2)**

1. Scientific Method & Lab Safety (SC.8.N.1.1; SC.7.N.1.2;SC.6.N.2.2)
2. Measurement (SC.8.E.5.1; SC.8.E.5.3; SC.8.E.5.7; SC.8.P.8.4;SC.7.E.6.5)
  - a. Algebraic Conversions
  - b. Data analysis and Interpretation
3. Motion (SC.8.E.5.7; SC.8.E.5.4; SC.8.E.5.9; SC.8.P.8.4; SC.6.P.13.3)
4. Forces (SC.8.E.5.4; SC.8.E.5.9; SC.7.N.1.5; SC.6.P.13.1)
  - Forces
  - Newton's Laws of Motion
  - Law of Universal Gravitation
  - Momentum
5. Energy (SC.8.L.18.4;SC.7.N.3.1; SC.7.P.11.2)
  - Forms of Energy
  - Energy Transformation
  - Law of Conservation of Energy
  - Energy Resources
6. Sound & Light (SC.8.E.5.5; SC.8.E.5.1; SC.7.N.1.5; SC.7.P.10.1; SC.7.P.10.3)
7. Thermal Chemistry (SC.8.E.5.6; SC.7.P.11.4; SC.7.E.6.5; SC.6.E.7.5)
  - Temperature, Phases of Matter,
  - Heat & Thermal Energy, Transfer of Heat
8. Work & Machines (SC.8.E.5.7; SC.7.N.1.5; SC.6.L.14.5; SC.6.E.7.4; SC.6.E.7.5)
  - Simple Machines,
  - Energy
9. Electricity & Magnetism

### **OBJECTIVES**

#### **Students will**

- **Become familiar with design of models with engineering process and scientific method**
- develop their sense of science process, investigation and data analysis and interpretation through
  - Personal research and
  - Use of data findings through technology.

# Student Hands on Exploration:

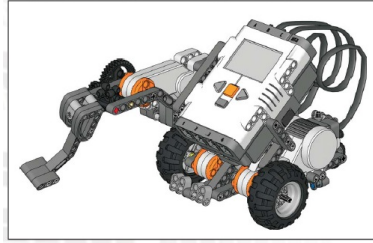

## INTRODUCTION

### BUILD. PROGRAM. GO!



#### Build

Build a robot. You can find building instructions for this model (Quick Start model) in this User Guide, in the software or at [www.MINDSTORMS.com](http://www.MINDSTORMS.com). Or you can use your imagination to build your own unique robot.

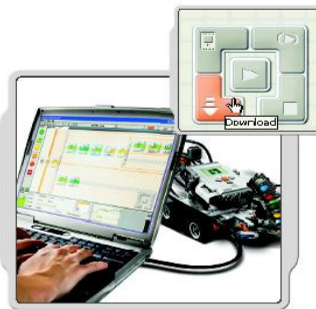

#### Program

Program your robot to do what you want. Use the LEGO® MINDSTORMS® NXT Software to create a program. Download the program to the NXT by using the USB cable or the wireless Bluetooth connection.



#### Go!

Run the program and watch your robot come to life.



### Quick Start

Use the Quick Start kit to get your first MINDSTORMS experience. In the Quick Start kit you will find everything you need to get off to a great start. It will only take you a few minutes to create your first MINDSTORMS robot, test it, and get a fun reaction.

The building instructions for your first robot starts on page 5 [opposite].

**Materials:** LEGO MINDSTORMS Lego Mindstorms NXT 2.0 Kit 9797

Mobile Device- wireless mini laptop for programming or Smart phone

Digital camera or phone camera for Video

Meter sticks, measuring & timing devices

Resources on LEGOs and engineering activities



User Guide - English 85478547 User Guide English Download size: 9.96 MB

Download time:33.6 kbit/s Modem: 40 min.

256 kbit/s cable or ASDL: 5 min.

1 Mbit/s cable or ASDL: 1 min.

4 Mbit/s cable or ASDL: 20 sec.

<http://mindstorms.lego.com/enus/support/buildinginstructions/8547/8547%20User%20Guide%20English.aspx>

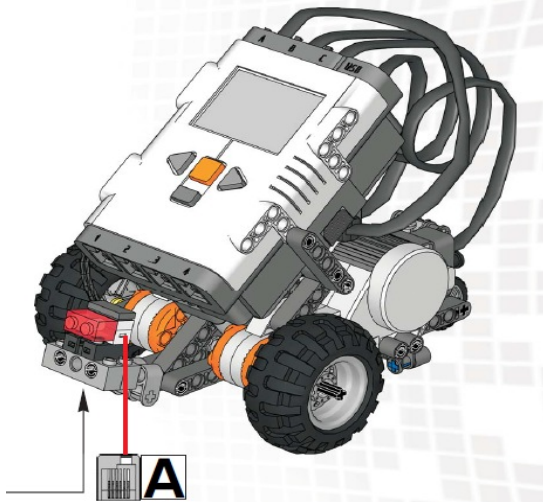

27

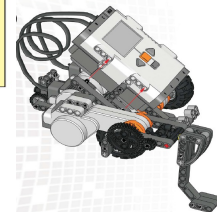
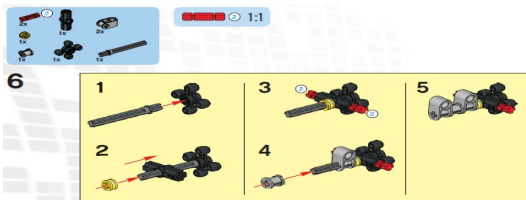
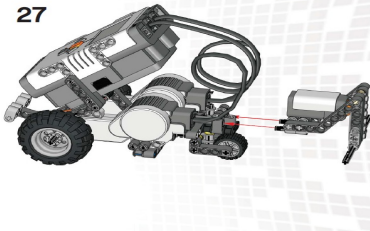

**Assessments:**

The assessments are primarily performance assessments based on rubrics given to students at the beginning of the project. This is based on assigned tasks performed, collaboration, participation, completed assignments, and presentation through technology.

## **Lesson 6: I Have an APP for That!**



### **Smart phones for Smart Technology Students'**

We love LEGO and we love Android, and it seems there's plenty of love between the two companies as well. LEGO has just launched [MINDroid for Android](#), a remote control app allowing users to operate their Mindstorm NXT robots from their smart phones. These are free APPs.

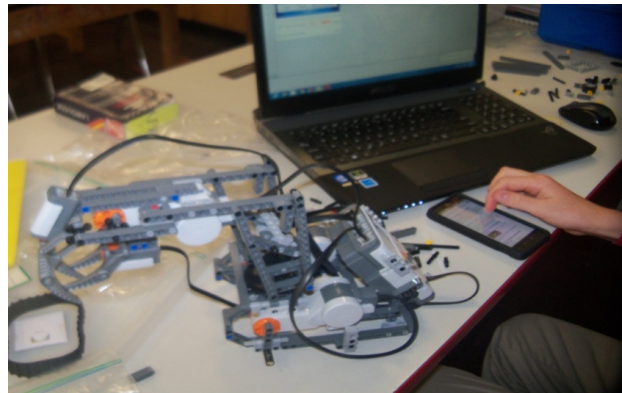

### **Free APP for remote control of MINDSTORMS NXT 2.0**

# **Bluetooth**<sup>®</sup> USING BLUETOOTH



Bluetooth is a technology that makes it possible to send and receive data without using wires or cables. Using Bluetooth, you can exchange programs between your computer and your NXT or even between your NXT and other NXTs. You can also establish a wireless connection between your computer and your robot to control it remotely!



If your computer does not have NXT compatible built-in Bluetooth capability, you must use a Bluetooth USB dongle. Make sure that you use the right type of Bluetooth USB dongle. Read more about the different types of Bluetooth USB dongles to use at [www.MINDSTORMS.com/bluetooth](http://www.MINDSTORMS.com/bluetooth)

The MINDdroid app is a remote-control application that allows you to create a wireless connection directly with your NXT, and once a connection is established, you can tilt and turn your phone to make the robot move forward, turn to the sides, and by pressing an action button on the phone's screen, and activate the Action motor.

To learn more about how to connect wirelessly to your NXT microcontroller via Bluetooth, or to create individual names for your NXT please check the 'NXT Technology' pages in your User Guide that comes with the LEGO MINDSTORMS NXT sets.

The source code for MINDdroid is released under the GPL v3 license and it is freely downloadable <http://github.com/NXT/LEGO-MINDSTORMS-MINDdroid>

<http://mindstorms.lego.com/en-us/news/readmore/default.aspx?id=227417>

<http://www.robotappstore.com/Pages/Model.aspx?Model=NXT>

<http://www.legoeducation.us/eng/categories/products/middle-school/lego-mindstorms-education-nxt>

# LESSON 7: The Masters of Metaphorosis

## Research & Development –Design of Inquiry Exploration

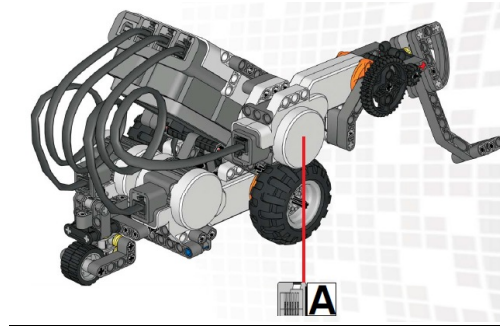

### Hands on STEM Design

Benchmark: Big Idea 1: The Practice of Science SC. 6. N.1.1

Materials: Lego Mindstorms NXT 2.0 Kit - 280.00 LEGO Education  
LEGO MINDSTORMS Education NXT Software 2.1- From: \$79.95 LEGO Education  
Laptop / Tablet with updated processor or  
SMART PHONE

This powerful, easy-to-use software for programming and data logging is icon based and incorporates **Robot Educator**, a step-by-step guide, from beginner to advanced levels. Data-logging functionalities, including a graph viewer, make it easy to collect and analyze data from sensors. The software incorporates a comprehensive digital user manual. The software is Mac OS X, Windows XP, Vista, and 7 compatible.

### Key Learning Targets:

- Using input and output devices and producing a simple set of sequential instructions linking cause and effect.
- Using the scientific inquiry process when gathering and analyzing data sets.
- Integrating math and science using physical constants, units of measurement, coordinate systems, min, max, mean, and linear formulas.

Activities: A Tour of the Solar System, Applause, Egyptians as Engineers, Boogie Bot

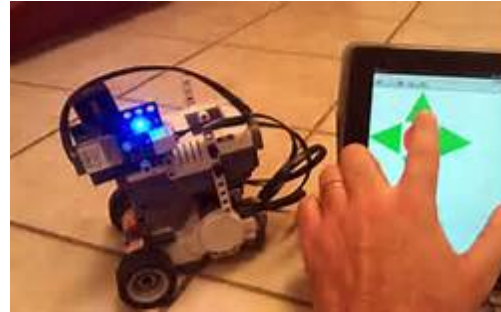
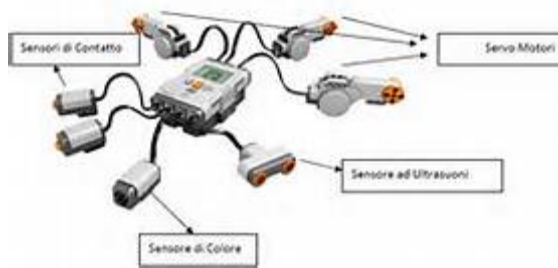

**Be LEGO® Smart.  
Be the Future.**

LEGO® smart students in middle school are building the future.

"They are learning the deeper things that truly can change the rest of their lives. They learn about teamwork, cooperative learning, skills that go beyond the science or the math."  
Matthew Collier, LAUNCH Senior High School

<http://www.legoeducation.us/eng/categories/products/middle-school>

### LEGO Competitions

<http://science.dadeschools.net/STEM/index.html>

Activities related to ISS and NASA STEM focused objectives can be found at <http://www.legospace.com/en-us/Videos/490525.aspx#490525>



## **Lesson 8: Competitions for Classes & Collaborative Learning Teams**

### **Tech Titans Robot Crush Challenge**

In a robot crush challenge, student teams challenge each other in operation, efficiency, and strength, either in a 1 to 1 contact battle or competing in an operational function challenge.

Students investigate what they should do in analyzing specific situation presented for competing in design and performance of a robotic product from Mindstorms Kit. Students plan what they need, create their product for the desired solution or task assigned, and work in teams to compete in the performance of their robotic device. They evaluate each other in a productive brainstorming process. Students assess the efficiency of the process and suggest ways of improving it. They reflect on their own involvement at every stage of the design process.

Student teams can video their activities and STEM competition to post on their website and science class website. They present their prototype on video to students and class and explain the objective of their robots and what they did to engineer their robots. They demonstrate what their objectives were as well as if they were achieved. This involves critical analysis, moving back and forth between the stages, helping students understand the design cycle with Science, technology, engineering, and mathematics.

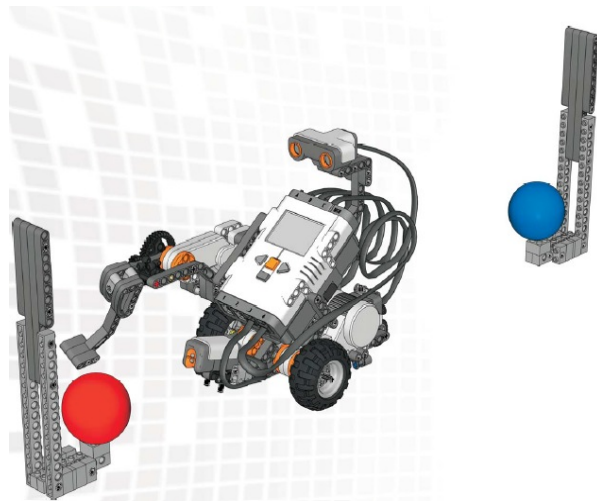

## MINDSTORMS – S.T.E.M. Activities

### Challenge Course Construction & Competition-Civil Engineering

Students can design and build their own competition course for classes to compete in Robotics remote operation, function, and mobility competitions. They will time their operations for speed and efficiency. Building their own courses incorporates engineering and design for greater understanding of their objectives and gives them control and ownership in their project and their objectives.

While there are course kits available for purchase, building their own course will help them understand how the sensors can be used for navigation and remote responses. It is also more accessible for students to build their own courses on boards due to limited funding.



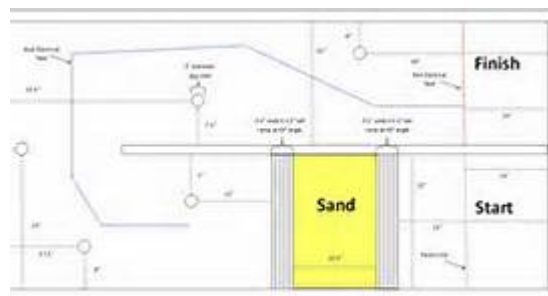

For teachers who prefer to purchase the course challenge kit information is provided below.

The *Green City Challenge Combo Pack* includes both the *Green City Challenge Set* and *Activity Pack* and is ideal as a step-by-step introduction to robotics in the classroom or as preparation for robotics competitions. The *Green City Challenge Set* contains three training mats, a challenge mat, and more than 1,300 elements for building the challenge models, such as a power plant, wind turbine, and dam. The training mats provide a field where students can test and practice their programming skills. The challenge mat offers a real-life setting for solving different missions so students can apply the skills acquired through the training.

The *Green City Challenge Activity Pack* includes seven easy-to-follow training activities, each supported by student worksheets, which guide the students from simple to more advanced programming. Students are then challenged to apply their programming and problem-solving skills by making their robots solve real-world engineering challenges related to renewable energy. Comprehensive teacher notes provide everything needed for easy implementation, including programming examples, building instructions, mission and rules, extension ideas, and more. Also includes a project that can be used for further research into the challenge topic of renewable energy.

The *Green City Challenge Set* and *Activity Pack* were designed for use with the LEGO® MINDSTORMS® Education NXT Base Set and Software (sold separately).

*Green City Challenge Combo Pack*  
Product ID: W999594 \$319.95



<http://www.legoeducation.us/eng/categories/products/middle-school>

# STEM Expo

Science, Technology, Engineering and Mathematics



South Florida Regional Science And Engineering Fair

<http://science.dadeschools.net/secme/default.html>

## STEM ACTIVITIES in ROBOTICS

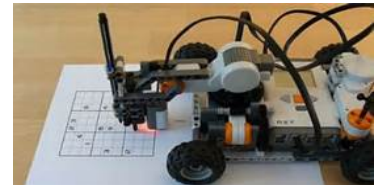

## After-School Robotics Competitions

Students in elementary, middle, and high school can really test their STEM skills through action-packed after-school robotics competitions. LEGO® Education proudly supports *FIRST*, a nonprofit organization dedicated to inspiring technology interest in today's students, to support a global network of robotics competitions.

The *FIRST* participants are truly LEGO smart and are building the skills needed to be our future leaders.



[http://www.legoeducation.us/eng/Competitions/fl.cfm?paID=4475#loc=competitions\\_w2\\_dec\\_2012](http://www.legoeducation.us/eng/Competitions/fl.cfm?paID=4475#loc=competitions_w2_dec_2012)

## Assessments

**Formative Assessment:** The comprehension questions and reflection questions can be used as formative assessment.

Comprehension and readiness questions will indicate whether the students understand the problem and the problem context, and reflection questions are meant to elicit students' thinking as they are working through the problem.

The questions are asked of students after they read the assignment (see Reading Appendix A). The teacher can ask the class to respond to the reading assignment and ensure understanding of vocabulary and concepts, before students begin working with the hands on inquiry.

Brainstorming discussions and questions can reveal any misunderstand or issues that students have as well as guide them to think about what they are doing.

**Feedback to Students:** Students will get feedback from the teacher about their performance or understanding during the lesson.

The brainstorming discussions in class and collaborative learning groups will initiate discussions and their design process in collaborative learning groups to clarify questions about what is expected of them.

They have an opportunity to use this feedback to improve their performance as they modify their models and design for better performance of the product throughout the activity.

### **Summative Assessment:**

Summative assessment will include criteria from Collaborative Learning Group Rubric and a final technical report written by each group about their product design, performance, and specifications.

(SEE APPENDIX F -Lesson 8 FOR RUBRIC)

## References

Reading assignment Retrieved from: <http://www.wisegeek.org/what-are-robots.htm>

<http://www.legospace.com/en-us/Videos/490525.aspx#490525>

<http://www.legoeducation.us/eng/categories/products/middle-school>

<http://www.legoeducation.us/eng/categories/products/middle-school/lego-mindstorms-education-nxt>

<http://www.legoeducation.us/eng/categories/products/middle-school>

[http://www.legoeducation.us/eng/Competitions/fl.cfm?paID=4475#loc=competitions\\_w2\\_dec2012](http://www.legoeducation.us/eng/Competitions/fl.cfm?paID=4475#loc=competitions_w2_dec2012)

<http://mindstorms.lego.com/en-us/news/readmore/default.aspx?id=227417>

<http://mindstorms.lego.com/enus/support/buildinginstructions/8547/8547%20User%20Guide%20English.aspx>

<http://mynasadata.larc.nasa.gov/science-processes/electromagnetic-diagram/>

<http://www.robotappstore.com/Pages/Model.aspx?Model=NXT>

<http://science.dadeschools.net/STEM/index.html>

<http://science.dadeschools.net/secme/default.html>

**Activities related to ISS and NASA STEM focused objectives can be found at**

<http://www.legospace.com/en-us/Videos/490525.aspx#490525>

**APPENDIX**  
**STUDENT HANDOUTS**

## **Appendix A    LESSON1: Reading Assignment**

### **Lesson 1: Reading Assignment**

#### INTRODUCTION TO ROBOTICS

What is a robot? Robots are:

1. Programmable machine for performing tasks.
2. Mechanical devices that can be programmed to carry out instructions and perform complicated tasks that are traditionally done by people.
3. Virtual machines that may resemble human forms and functions similar to humans
4. Can represent artificial intelligence or human functions in science fiction.
5. Human like machine which works or behaves mechanically, without emotion
6. Forms of robots may be android, humanoid, computerized machine

Robotics is a branch of technology dealing with planning, design, construction, operations and application of robots. This component is integrated with computer systems for control, sensory feedback, and information processing. Technology works with automated machines that can be programmed to work in place of humans in dangerous environments and hazardous situations. Robots may resemble humans taking a humanoid form, or look like any other machine that can be remote controlled or automated to operate independently, as programmed.

Robotics that operate independently and automated, date back in history to the Classical Era of Rome and Greece. It only began to become common and more effective in the 20<sup>th</sup> century.

Robotics is a growing industry in society today, as technology evolves and progresses in people's daily lives. Robotics is integral in many industries. The research, design and manufacturing of robots serve many practical purposes in many fields, including commercially, militarily, and other aspects. Robots can function in areas that are dangerous or impossible for humans to function.

**Excerpts from <http://www.wisegeek.org/what-are-robots.htm>**

#### History of Robots

In 1927 the Maschinenmensch ("machine-human) gynoid humanoid robot (also called "Parody", "Futura", "Robotrix", or the "Maria impersonator") was the first and perhaps the most memorable depiction of a robot ever to appear on film was played by German actress Brigitte Helm in Fritz Lang's film Metropolis.

In 1942 the science fiction writer Isaac Asimov formulated his Three Laws of Robotics.



In 1948 Norbert Wiener formulated the principles of cybernetics, the basis of practical robotics.

Fully autonomous robots only appeared in the second half of the 20th century. The first digitally operated and programmable robot, the Unimate, was installed in 1961 to lift hot pieces of metal from a die casting machine and stack them. Commercial and industrial robots are widespread today and used to perform jobs more cheaply, accurately and reliably, than humans. They are employed in jobs which are too dirty, dangerous, or dull to be suitable for humans. Robots are widely used in manufacturing, assembly, packing and packaging, transport, earth and space exploration, surgery, weaponry, laboratory research, safety, and the mass production of consumer and industrial goods.

What are Robots?

The word robot is usually used to refer to a mechanical agent that performs one or more tasks in which it mimics a human or animal agent either through programming or commands. Another word used synonymously is automaton. Virtual robots exist, but are most often called by the abbreviated name bots.

This term comes from the Czech word *robota*, which means drudgery or servitude. It was coined by Karel Capek, a Czech playwright, in his play *R.U.R.*, which stands for "Rossum's Universal Robots." It was published in 1921, and entered English in 1923. The field of study is referred to as robotics, and people who specialize in it are called roboticists.

Robots can be classified in a number of ways. Creators may use the means of locomotion as their categories, differentiating their creations by whether they are static, on the one hand, or whether they have treads, a propeller, fins, legs, wheels, rotors, or other means of propulsion.

The National Aeronautics and Space Administration (NASA), however, classify robots in several different ways. First, it classifies them by whether they work on Earth or in space. Second, it classifies them by the industry they work in. Third, it classifies them by the type of jobs they do.

These machines are employed in industries such as manufacturing, medicine, the military, and transportation. They are used widely in assembly operations, in which they complete a range of tasks, including the following: Arc welding, Die casting, Fettling machines, Gas welding Manipulating machine tools, Placement of items into a structure that's being built, Sealant application, Spot welding, Spray painting.

Robots are also used for parts inspections, making glass, cleaning, monitoring radiation, sorting, loading and unloading, fastening, forging, and sand blasting. Because they are not human, they can be used in hazardous situations such as firefighting, military warfare, and bomb detection. Surgical robots are under development and robotic hands, for example, are already used in some surgical operations, allowing the human surgeon more control in laparoscopic procedures, those done through a very small incision.

Droid is the name for a type of intelligent robot. The droid comes from a shortening of the word android, which means "an automaton that has features of a human being." Examples of droids include C-3PO and R2-D2 of Star Wars fame. George Lucas, the creator of Star Wars, has trademarked the term.

In the real world, a number of companies are working on android robots that closely resemble humans and are able to interact with real people. Much of the current work is being done in Japan and South Korea. Some South Korean companies hope to make them a household item in the future.

Robots on wiseGEEK:

While the humanoid robot Dexter is capable of jumping, for example, it has been engineered almost exclusively for that purpose, and its ability to jump is still very limited and awkward when compared to a human. Even with their currently limited capabilities, humanoid robots still have a number of uses, and in the future they may be capable of doing many important tasks.

In a medical lab, for example, an articulated robot might be used to deliver and carry samples around the lab. Basic articulated robots are sometimes available in robotics kits, allowing people who are just starting to explore robotics to play with rotary joints and to get a feel for how they operate.

Toy Robots on wiseGEEK:

Classic robot toys can take you back to the mid-20th century, when robots became part of the vocabulary of science fiction or futuristic stories. The very first toy robot is believed by some to be a Japanese toy called "Liliput," which ran on clockwork mechanics.

First, decide why you need the robot. If it is for fun, then you know you only have to look for toy robots. If you need a small robot to explore a small space or to perform a function such as repairing something, then you can narrow down your search by ignoring robots that do not perform this function.

Robots Kits on wiseGEEK:

The kit lays the groundwork, allowing the user to understand how these systems work and to play around to see how various changes can be made. When buying robot kits, people should pay attention to the age and skill level recommendations provided, as kits can vary in nature from very simple projects for children in elementary school to complex kits which are designed to be used in labs and research facilities.

Choosing the best robot for kids depends on the age of the child and the purpose of the robot. There are many educational robot kits that teach the basics of robotics, but there are also toy robot kits made purely for enjoyment.

Programmable Robots on wiseGEEK:

The process of robot welding can remove all human involvement from both the handling and welding of various materials. It typically involves programmable robots capable of performing these functions without any human interference, and with limited supervision.

Programmable matter is necessary for the shape transitions, as well as the ability to interact with the user, send data, and receive information. In addition to directives from the user, some programmable matter may interact with robots and computer programs which can control it automatically.

From: <http://www.wisegeek.org/what-are-robots.htm>

<u>Date</u>	<u>Significance</u>	<u>Robot Name</u>	<u>Inventor</u>
3 <sup>rd</sup> century B.C. and earlier	One of the earliest descriptions of automata appears in the Lie Zi text, (1023–957 BC). A mechanical engineer known as Yan Shi, an 'artificer', who allegedly presented the king with a life-size, human-shaped figure of his mechanical handiwork.		Yan Shi
1 <sup>st</sup> century A.D. and earlier	Descriptions of more than 100 machines, including a fire engine, wind organ, coin-operated machine, and a steam-powered engine, in Pneumatica and Automata by Heron of Alexandria		Ctesibius, Philo of Byzantium, Heron of Alexandria,etal
c. 420 B.C.E	A wooden, steam propelled bird, which was able to fly		Archytas of Tarentum
1206	Created early humanoid, programmable automation	Robot band, hand-washing automation, automated peacocks	Al-Jazari
1495	Designs for a humanoid robot	Mechanical knight	Leonardo da Vinci
1738	Mechanical duck that was able to eat, flap wings, and excrete	Digesting Duck	Jacques de Vaucanson
1898	Nikola Tesla demonstrates first radio-controlled vessel.	Teleautomaton	Nikola Tesla
1921	First fictional automaton called "robots" appear in the play R.U.R.	Rossum's Universal Robots	Karel Čapek
1930s	Humanoid robot exhibited at the 1939 and 1940 World's Fairs	Elektro	Westinghouse Electric Corporation
1948	Simple robots exhibiting biological behaviors	Elsie and Elmer	William Grey Walter
1956	First commercial robot, from Unimation company founded by George Devol & Joseph Engelberger.	Unimate	George Devol
1961	First installed industrial robot	Unimate	George Devol
1973	First industrial robot - six electromechanically driven axes	Famulus	KUKA Robot Group
1974	The world's first microcomputer controlled electric industrial robot, IRB 6 from ASEA.. The design of this robot was patented 1972.	IRB 6	ABB Robot Group
1975	Programmable universal manipulation arm, a Unimation product	PUMA	Victor Scheinman

## **Appendix B Lesson 2: The Design Cycle-**

The four elements of the design cycle illustrated below are:

- 1. Investigate**
- 2. Plan**
- 3. Create a product/solution**
- 4. Evaluate**



The process is rarely a simple linear progression.

It usually involves critical analysis and moving back and forth between the stages.

## Lesson 2: Experimental Design Diagram

This form should be completed before experimentation.

<b>Title:</b>	
<b>Problem Statement:</b>	
<b>Null Hypothesis:</b>	
<b>Research Hypothesis:</b>	
<b>Test variable (TV) or (Independent variable) (IV)</b>	
<b>Number of Tests:</b> Subdivide this box to specify each variety.	
<b>Control Test:</b>	
<b># of Trials per Test:</b>	
<b>Outcome Variable (OV)</b>  <b>or Manipulated / Dependent Variable (DV)</b>	
<b>Controlled Variables or Variables Held Constant</b>	<ol style="list-style-type: none"> <li>1.</li> <li>2.</li> <li>3.</li> <li>4.</li> <li>5.</li> <li>6.</li> </ol>

# ENGINEERING DESIGN PROCESS

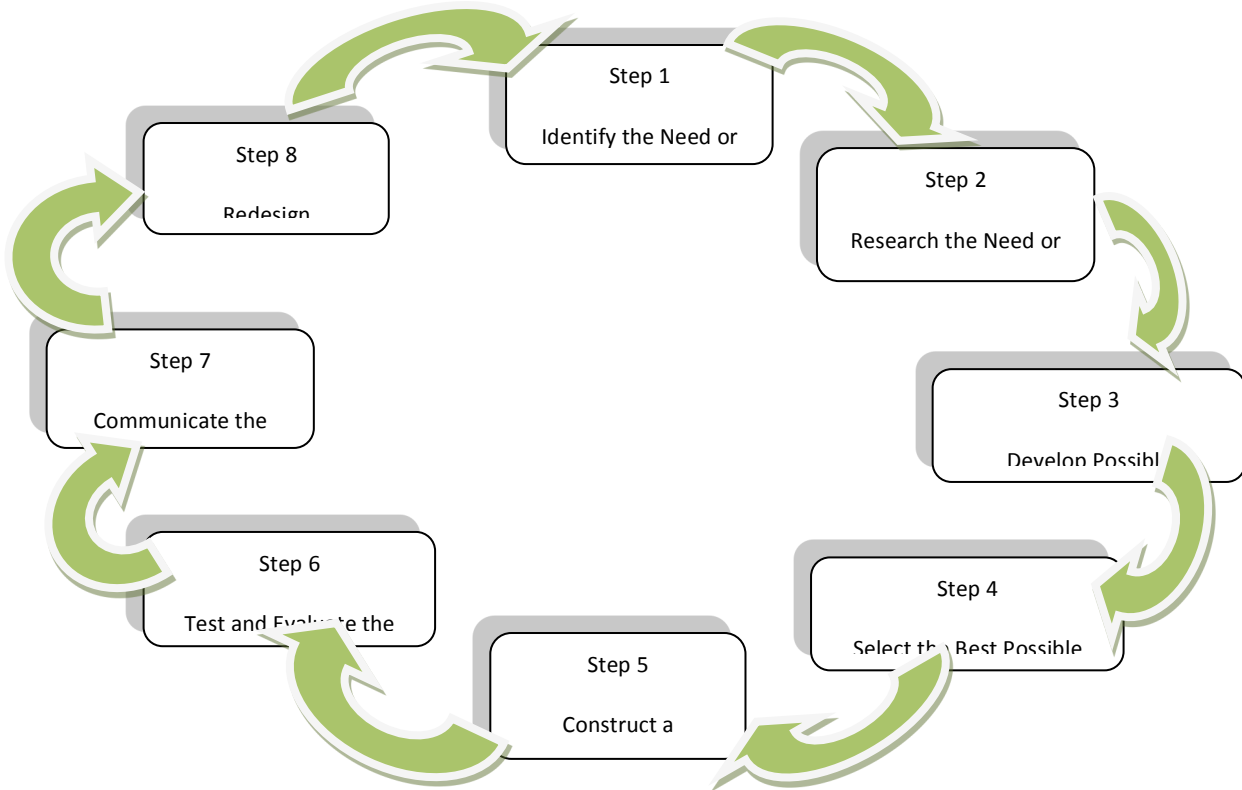

1. Identify the need or problem
2. Research the need or problem
  - a. Examine current state of the issue and current solutions
  - b. Explore other options via the internet, library, interviews, etc.
  - c. Determine design criteria
3. Develop possible solutions
  - a. Brainstorm possible solutions
  - b. Draw on mathematics and science
  - c. Articulate the possible solutions in two and three dimensions
  - d. Refine the possible solutions
4. Select the best possible solutions
  - a. Determine which solutions best meets the original requirements
5. Construct a prototype
  - a. Model the selected solutions in two and three dimensions
6. Test and evaluate the solutions
  - a. Does it work?
  - b. Does it meet the original design constraints?
7. Communicate the solutions
  - a. Make an engineering presentation that includes a discussion of how the solutions best meets the needs of the initial problem, opportunity, or need
  - b. Discuss societal impact and tradeoffs of the solutions
8. Redesign
  - a. Overhaul the solutions based on information gathered during the tests and presentation

## Appendix C      **Rubrics for Lesson 2:**

The rubric below should be used when grading lab reports/conclusions to ensure that students are effectively connecting their claim to their evidence to provide logical reasons for their conclusions.

### **Base Explanation Rubric**

Component	Level		
	0	1	2
<b>Claim</b> - A conclusion that answers the original question.	Does not make a claim, or makes an inaccurate claim.	Makes an accurate but incomplete claim.	Makes an accurate and complete claim.
<b>Evidence</b> – Scientific data that supports the claim. The data needs to be appropriate and sufficient to support the claim.	Does not provide evidence, or only provides inappropriate evidence (evidence that does not support the claim).	Provides appropriate but insufficient evidence to support claim. May include some inappropriate evidence.	Provides appropriate and sufficient evidence to support claim.
<b>Reasoning</b> – A justification that links the claim and evidence. It shows why the data count as evidence by using appropriate and sufficient scientific principles.	Does not provide reasoning, or only provides reasoning that does not link evidence to claim	Provides reasoning that links the claim and evidence. Repeats the evidence and/or includes some – but not sufficient – scientific principles.	Provides reasoning that links evidence to claim. Includes appropriate and sufficient scientific principles.

[www.science.dadescschools.net](http://www.science.dadescschools.net)



## Appendix D    Lesson 3: Forms of Energy Use in Our

### **Everyday Lives Student Activity Sheet -**

**On the Trail of Energy, Based on an article in *Science & Children Magazine*,  
Published by the National Science Teachers Association, May 2002, developed by the Bureau of  
Land Management,**

**URL:**[http://www.blm.gov/wo/st/en/res/Education\\_in\\_BLM/Learning\\_Landscapes/For\\_Teachers/science\\_and\\_children/energy/index/energy4.html](http://www.blm.gov/wo/st/en/res/Education_in_BLM/Learning_Landscapes/For_Teachers/science_and_children/energy/index/energy4.html)



**Mechanical Energy** - The energy of position and motion.

**Chemical Energy** - The energy that bonds molecules together. Chemical energy is released from a chemical reaction such as burning wood, coal, or oil. Our digested food releases chemical energy for use by the body.

**Radiant Energy** - Energy that travels in waves, such as Sunlight, radio waves, and X-rays.

**Nuclear Energy** - The kind of energy produced when the nuclei of atoms split or join together. Nuclear power plants split the nuclei of uranium atoms in a process called fission. The Sun combines the nuclei of hydrogen atoms in a process called fusion. (Note: Other than the Sun itself, no examples of nuclear energy are shown in the poster.)

**Thermal Energy** - Heat, the energy of moving and vibrating molecules. Geothermal energy is an example of thermal energy.

**Electrical Energy** - The energy of moving electrons. Electricity is electrons moving through a wire. Lightning is another example of electrical energy.

**Explain-** Circle and label examples of different types of energy sources depicted in the poster, such as solar, gas, electric, wind. (Note: Some sources may not actually be shown, but implied, such as the gasoline in the car.)

Work in small groups to identify examples of energy transformations.

Then, explain to others in the class the ones you've found.

## Appendix E

### Lesson 4: What is Light? Where does light come from?

Light is a form of energy. Our eyes change visible light energy waves into something we can see. Visible light energy is just one form of light energy. There are invisible forms of light energy that we cannot see without technology, such as infrared, ultraviolet, radio, and x-ray light energy. This radiant light energy is generated by waves.

A demonstration of light waves with a slinky toy can be used to show how waves vibrate in different wavelengths. Wavelengths correspond to different colors and heat. White light contains all the wavelengths of the visible spectrum and color is the product of the visible light energy. Primary colors of the visible spectrum are red, blue, and green.

Light waves can be reflected or refracted.

Light waves can bounce off an object; this is called *reflection*, such as a mirror, glass, or water. Light waves refract when they are bent as they pass through a clear object, light lenses of glasses or traveling through water. Different lengths of light waves are all reflected in the same way but refract differently. Red waves, with the slowest frequency, bend the least and violet light waves with the highest frequency bend the most. This is demonstrated in rainbow effects when light bounces off prisms, glass and raindrops. The brightness of any light source is determined by the amount of light energy it has.

Light energy is used by engineers. Engineers have learned to control light using things like prisms and magnifying lenses. Engineers use light in controlling medical equipment, x-ray machines, telescopes, cameras, computers and microscopes.

Light is a type of energy formed by a combination of electrical and magnetic rays, known as electromagnetic (EM) waves. Visible light is only one type of EM wave. Different kinds of electromagnetic waves are used for many different purposes. Radio transmitters generate artificial radio waves that carry radio and television programs in coded form by varying the height of the waves. X-Rays are used to penetrate soft tissue but is blocked by denser materials, so X-Rays can be used for medical diagnosis.

Light energy is created by a combination of electrical and magnetic fields. At times, light travels in waves showing typical wave features. The color of light depends on the length of the wavelength of the beam of light. At other times, light seems to be a stream of tiny particles or packets of energy called photons. Scientists accept both ways of understanding light. The combinations of these two properties demonstrate the "wave-particle duality" of light. Nothing travels faster than light, which travels at a speed of 186,000 miles (299,792 kilometers) per second.

[http://imagine.gsfc.nasa.gov/docs/science/know\\_11/emspectrum.html](http://imagine.gsfc.nasa.gov/docs/science/know_11/emspectrum.html)

## VOCABULARY

- Convergence:** A process of coming together or the state of having come together toward a common point.
- Electromagnetic spectrum:** The entire range of wavelengths or frequencies of electromagnetic radiation extending from gamma rays to the longest radio waves and including visible light. In order of decreasing frequency: cosmic-ray photons, gamma rays, x-rays, ultraviolet radiation, visible light, infrared radiation, microwaves and radio waves.
- Focal point:** A point of convergence of light (or other radiation) or a point from which it diverges. Also called the focus.
- Indigo:** A dark blue to grayish purple blue color. The hue found on the visible spectrum between blue and violet. Named after the blue dye obtained from the indigo plant.
- Lens:** A curved piece of glass that refracts light waves.
- Light energy:** Visible light energy, such as from a light bulb, fireflies, computer screens or stars, is one form of electromagnetic energy. Others forms include infrared, ultraviolet, radio and x-ray. Human eyes are detectors of visible light energy.
- Magnify:** To increase the apparent size of, especially by means of a lens.
- Polarization:** The phenomenon in which waves of light or other radiation are restricted in direction of vibration.
- Prism:** A solid object whose bases or ends have the same size and shape and are parallel to one another, and each of whose sides is a parallelogram. A transparent body of this form, often of glass and usually with triangular ends, used for separating white light passed through it into a spectrum or for reflecting beams of light.
- Rainbow:** An arc of colors, usually identified as red, orange, yellow, green, blue, indigo and violet, that appears in the sky opposite the sun as a result of the refractive dispersion of sunlight in drops of rain or mist. A similar arc or band, as one produced by a prism or by iridescence.
- Refract:** The bending of light as it crosses the between the surface of two transparent materials.
- Refraction:** The ability of light to bend when it crosses a transparent medium.
- Visible light spectrum:** The wavelengths of the electromagnetic spectrum that we can see. Every light wavelength in the visible spectrum corresponds to a specific color White light contains all of the wavelengths of the visible light spectrum. See Figure 1.
- Wave:** (Physics) A disturbance traveling through a medium by which energy is transferred from one particle of the medium to another without causing any permanent displacement of the medium itself.
- Wavelength:** The length between peaks or troughs of a wave. This distance determines the color of a beam of light.

# THE ELECTROMAGNETIC SPECTRUM

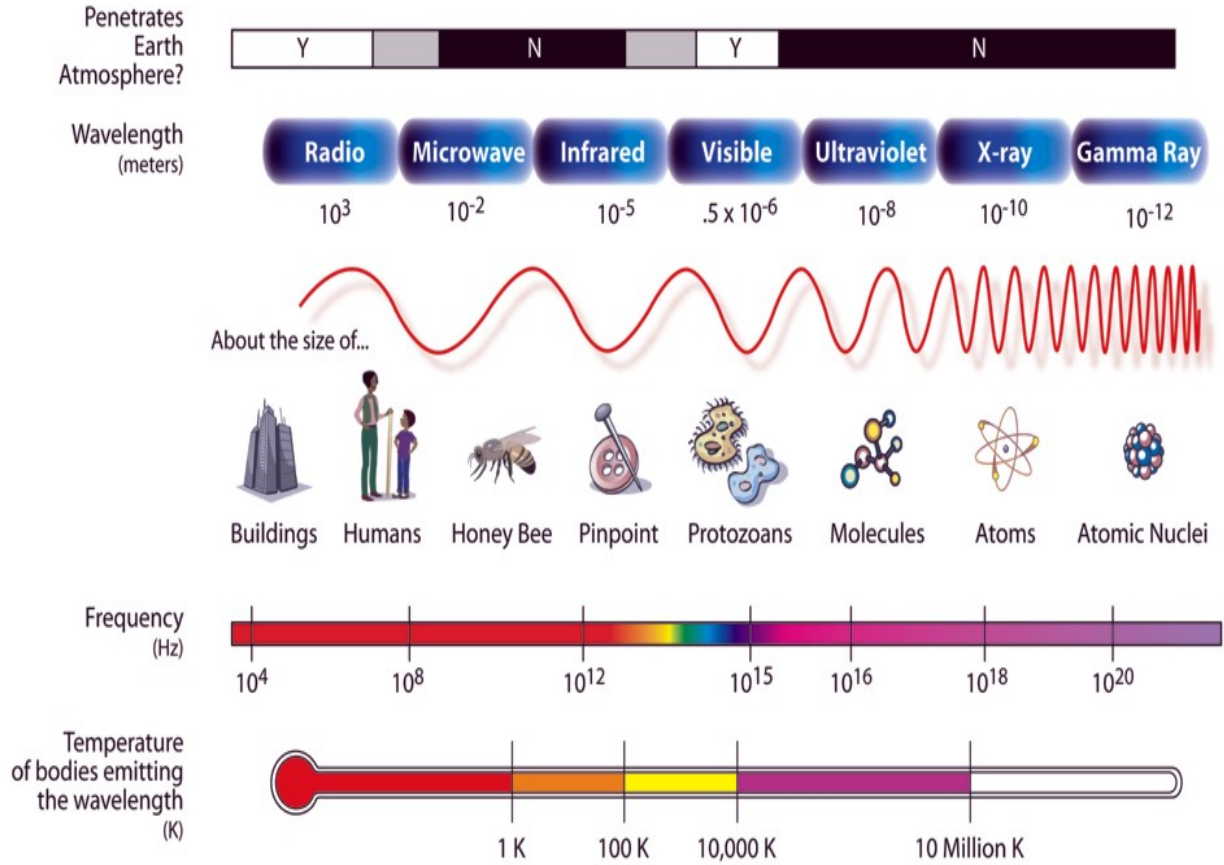

[http://imagine.gsfc.nasa.gov/docs/science/know\\_l1/emspectrum.html](http://imagine.gsfc.nasa.gov/docs/science/know_l1/emspectrum.html)

## Appendix F

## RUBRICS

### COLLABORATIVE WORK SKILLS: SCIENCE PROJECT

CATEGORY	4	3	2	1
<b>Focus on task</b>	Consistently stays focused on the task. Very self-directed.	Focuses on the task and what needs to be done most of the time. Other group members can count on this person.	Focuses on the task and what needs to be done some of the time. Others must sometimes remind to keep this person on-task.	Rarely focuses on the task and what needs to be done. Lets others do the work.
<b>Quality of Work</b>	Provides work of the highest quality.	Provides high quality work.	Provides work that occasionally needs to be checked & redone by members.	Provides work that usually needs to be checked & redone by members.
<b>Working with Others</b>	Almost always listens, shares, & supports efforts of others. Tries to keep team working well together.	Usually listens, shares, & supports efforts of others. Does not disrupt the team.	Often listens, shares, & supports efforts of others, sometimes not a good team member.	Rarely listens, shares, & supports efforts of others. Often is not a good team player.
<b>Contributions</b>	Routinely provides useful ideas participating in discussions. A definite leader - contributes a lot of effort.	Usually provides useful ideas participating in discussions. A leader - contributes a lot of effort, who tries hard!	Sometimes provides useful ideas when participating in discussions. A satisfactory group member who does what is required.	Rarely provides useful ideas in participating in discussion. May refuse to participate.
<b>Researching / Fact Finding</b>	Provides useful ideas when participating in the group discussion. Researches many sources.	Usually provides useful ideas when participating in group discussion. Researches several sources.	Sometimes provides useful ideas when participating in group discussion with minimal research.	Rarely provides useful ideas and with no evidence. May refuse to participate.
<b>Problem-solving &amp; Reasoning</b>	Actively looks for and suggests solutions to problems.	Refines solutions suggested by others.	Does not suggest or refine solutions, but is willing to try out solutions suggested by others.	Does not try to solve problems or help others solve problems. Lets others do the work.
<b>Presentation</b>	Almost always listens to, shares with, and supports the efforts of others in the team. Tries to keep people working well together.	Usually listens to, shares with, and supports the efforts of others in the group. Does not cause disruptions in the team.	Often listens to, shares with, and supports the efforts of others in the group but sometimes is not a good team member.	Rarely listens to, shares with, and supports the efforts of others in the group. Often is not a good team member.

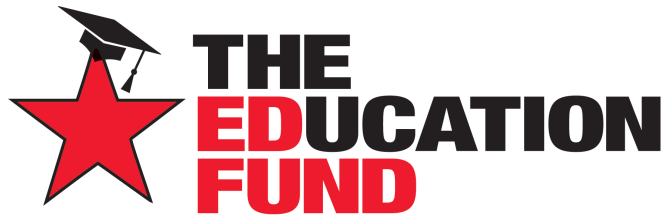

FOR EXCELLENCE IN MIAMI-DADE PUBLIC SCHOOLS

## *IMPACT II Adapter*

### *Grant Application*

***M-DCPS teachers, media specialists, counselors or assistant principals may request funds to implement an IMPACT II idea, teaching strategy or project from the Idea EXPO workshops and/or curriculum ideas profiled annually in the Ideas with IMPACT catalogs.***

***Most catalogs can be viewed at The Education Fund web site at [www.educationfund.org](http://www.educationfund.org) under the heading, Publications.***

***How-to booklets for each idea can be accessed at***

***[www.educationfund.org](http://www.educationfund.org) under Publications. They are listed under***

***Curriculum Idea Packets.***

- Open to all K-12 M-DCPS teachers, counselors, media specialists
- Quick and easy reporting requirements
- Grants range from \$150 - \$400 **except ROBOTICS grants up to \$500.**
- Grant recipients recognized at an Awards Reception in late January.

To apply, you must contact the teacher (the Disseminator) who developed the idea. Contact may be made by attending a workshop at the Idea EXPO given by the IMPACT II disseminator teacher.

**Project funds are to be spent within the current school year or an extension may be requested. An expense report with receipts is required by June 15<sup>th</sup>.**

**APPLICATION DEADLINE: December 10th.**

***Apply online at [www.educationfund.org](http://www.educationfund.org).***

For more information contact:

Lorna Pranger Valle

The Education Fund

305-892-5099, ext. 18;

[Lvalle@educationfund.org](mailto:Lvalle@educationfund.org)

***General Information***

Teacher's Name

Employee #

E-mail Address

---

School Name

---

School Address

City

Zip Code

---

Home Address

Zip Code

Teacher Cell and/or Home Phone Number \_\_\_\_\_

I hereby apply for an Adapter Grant:

---

Teacher's Signature

Date

I am aware of this application:

---

Principal's Signature

Date



## Project Information

Name of Project You Are Adapting: \_\_\_\_\_

Name of Project Disseminator teacher: \_\_\_\_\_

***You are required to make contact with the disseminator teacher who developed the project.***

I made contact via:   \_\_\_ Workshop/Idea EXPO (preferred)           \_\_\_ Email  
                                  \_\_\_ Telephone   \_\_\_ Other (please specify) \_\_\_\_\_

Apply online at [www.educationfund.org](http://www.educationfund.org) or print and mail the application to:

**The Education Fund**

**900 NE 125<sup>th</sup> Street**

**Suite 110**

**North Miami, FL 33161**

## Project Implementation

Teaching Assignment (grade level & subject): \_\_\_\_\_

Number of Students Participating: \_\_\_\_\_ Level of Achievement: \_\_\_\_\_

Ethnic Distribution of Project: \_\_\_\_\_% Hispanic \_\_\_\_\_% Black \_\_\_\_\_% White \_\_\_\_\_% other

How will the project help low-performing students (if applicable) in your classroom? \_\_\_\_\_

---

What is the educational need for this project in your class? \_\_\_\_\_

---

What changes (if any) will be made to the original project idea? We encourage you to adapt to your classroom needs.

---

---

---

### *Budget Information*

What materials or equipment are needed to adapt this project to your class?

Item and Description

Cost

---

---

---

Total Funds Requested: \_\_\_\_\_

**Deadline to apply is December 10th.** Apply at [www.educationfund.org](http://www.educationfund.org) under IMPACT II.